



METER

TEROS 32



TABLE OF CONTENTS

1. Introduction	1
2. Operation	2
2.1 Installation	2
2.1.1 Installation Angle	5
2.1.2 Installation Depth	13
2.1.3 Drilling With the Tensiometer Auger	16
2.2 Filling the Ceramic Cup	16
2.3 Connecting	18
2.3.1 Connect to METER Data Logger	19
2.3.2 Connect to Non-METER Data Logger	19
2.4 Communication	22
2.5 Removal	23
3. System	24
3.1 Specifications	24
3.2 Components	27
3.3 Theory	28
3.3.1 Water Potential Measurements	28
3.3.2 Barometric Compensation	29
3.3.3 Measurement Range	29
3.3.4 Temperature	31
4. Service	32
4.1 Calibration	32
4.2 Maintenance	32
4.3 Cleaning	32

4.3.1 Cleaning the Exterior	33
4.3.2 Cleaning the Ceramic Cup	33
4.4 Troubleshooting.....	33
4.5 Customer Support.....	34
4.6 Terms and Conditions	35
Index	36



1. INTRODUCTION

Thank you for choosing the TEROS 32 Soil Water Potential and Temperature sensor from METER Group.

TEROS 32 sensors measure the soil water potential and soil temperature. TEROS 32 applications include measuring soil water availability, controlling irrigation, and measuring soil-water storage.

The TEROS 32 sensor is designed for long-term, continuous field measurements. This manual guides the customer through sensor features and describes how to use the sensor successfully.

Verify all TEROS 32 components are included and appear in good condition:

- Tensiometer
- Flexible conduit with dust cap
- Flow diversion disk

METER recommends testing the sensors with a data logging device and software before going to the field.

2. OPERATION

Please read all instructions before operating the TEROS 32 to ensure it performs to its full potential.

PRECAUTIONS

METER sensors are built to the highest standards, but misuse, improper protection, or improper installation may damage the sensor and possibly void the manufacturer's warranty. Before integrating TEROS 32 into a system, make sure to follow the recommended installation instructions and have the proper protections in place to safeguard sensors from damage. If installing sensors in a lightning-prone area with a grounded data logger, see the application note [Lightning surge and grounding practices](#).

2.1 INSTALLATION

When selecting a site for installation, it is important to remember that the soil adjacent to the sensor surface has the strongest influence on the sensor reading.

Consider the following items before installing TEROS 32:

- **Ceramic cup.** Do not touch the ceramic cup. Skin oil, sweat, or soap residues will influence the ceramic hydrophilic performance.
- **Freezing temperatures.** Tensiometers are filled with water and therefore are susceptible to freezing! Never leave tensiometers exposed when freezing temperatures might occur! Refilling the sensor may not be possible under freezing temperatures.
- **Electrical installation.** If connecting the data logger to a main power supply, consult qualified personnel.

Follow the steps listed in [Table 1](#) to set up the TEROS 32 and start collecting data. The refill syringe is not included with the TEROS 32 and must be purchased separately.

Table 1 Installation

Tools Needed	<p>Dead blow hammer</p> <p>Deionized water</p> <p>Refill syringe</p> <p>PVC casing or flexible conduit</p> <p>Cable inserting tool (if using long flexible conduits)</p> <p>Shovel (if digging a trench)</p> <p>Tensiometer auger</p>
--------------	--

Table 1 Installation (continued)

Preparation

Determine Installation Configuration

Decide installation angle ([Section 2.1.1](#)).

Calculate installation depth ([Section 2.1.2](#)).

NOTE: A barometric reference sensor, either standalone or as part of a data logger, is needed as part of the system configuration to accurately measure soil water potential ([Section 3.3.2](#)).

Conduct System Check

Plug the sensor into the logger ([Section 2.3](#)) to make sure the sensor is functional.

There are two methods for installing TEROS 32, as described in [Table 2](#).

Create Hole

To install the TEROS 32 into the soil, use the TEROS 32 auger available from METER.

Avoid interfering objects, such as roots or rocks.

Mark the required drilling depth on the TEROS 32 auger ([Section 2.1.2](#)).

Use a level set to the predetermined installation angle ([Section 2.1.1](#)) to ensure the auger is drilling at the correct angle.

Drill a hole stepwise until the marker reaches the soil surface ([Section 2.1.3](#)). Avoid soil compaction by drilling with several steps (maximum drilling step length = blade length of TEROS 32 auger).

Insert Sensor

NOTE: Do not touch the ceramic cup. Skin oil, sweat, or soap residues will affect its hydrophilic performance.

Slip the flow diversion disk onto the shaft and push the shaft gently into the soil surface.

- For downward installations, the yellow sticker must face up.
- For upward installations, the yellow sticker must face down.

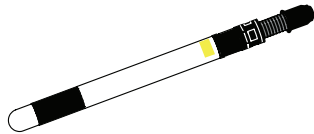

Sticker face up

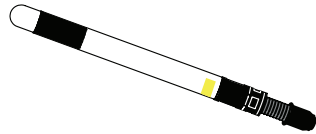

Sticker face down

Carefully and slowly insert the TEROS 32 into the borehole until the drilling depth is reached.

When the final depth is reached, check that the sticker is properly oriented. To correct the orientation, rotate the sensor clockwise until it is in the correct position. Do not rotate sensor counterclockwise or the ceramic cup may become unscrewed. To check TEROS 32 orientation with ZENTRA Utility, see [Section 2.1.1](#).

Installation

Table 1 Installation (continued)

Installation (continued)	<p>Fill the Tensiometer</p> <p>NOTE: More details of this process are in Section 2.2.</p> <p>Fill the syringe with deionised water.</p> <p>Close the valve and degas the water by drawing up the syringe.</p> <p>Unplug the refilling hose from the refilling tube.</p> <p>For a downward installation, connect the syringe to the marked refilling tube. For an upward installation, connect the syringe to the unmarked refilling tube.</p> <p>Press at least 20 mL of deionised and degassed water into the ceramic cup.</p> <p>Reconnect the refilling hose onto the refilling tube.</p>
	<p>Secure and Protect Cables</p> <p>NOTE: Improperly protected cables can lead to severed cables or disconnected sensors. Cabling issues can be caused by many factors such as rodent damage, driving over sensor cables, tripping over cables, not leaving enough cable slack during installation, or poor sensor wiring connections.</p> <p>Install cables in conduit or plastic cladding when near the ground to avoid rodent damage.</p> <p>Gather and secure cables between the TEROS 32 and the data logger to the mounting mast in one or more places.</p> <p>Connect to Logger</p> <p>Plug the sensor into a data logger.</p> <p>Use the data logger to make sure the sensor is reading properly.</p> <p>Verify that these readings are within expected ranges.</p> <p>For more specific instructions on connecting to data loggers, refer to Section 2.3.</p> <p>NOTE: Electrical installations must comply with the safety and EMC requirements of the country in which the system is to be used.</p>

[Table 2](#) contains brief descriptions for typical installation methods in greater installation depths. Each has its own advantages and disadvantages. For more information about which installation method is best for specific applications, please contact [Customer Support](#).

Table 2 Installation methods

Auger

To dig a borehole just the right size METER recommends using the tensiometer auger (Section 2.1.3).

This method works best for remote or undisturbed measurement sites, as the refilling tube and sensor cable are exposed and easily accessible.

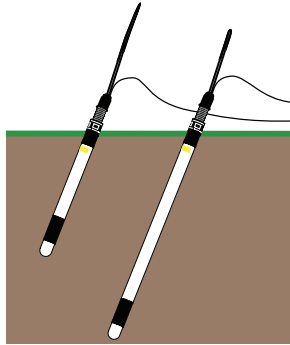
**Advantage**

Minimizes soil disturbance at measurement site.

Sensor can be easily removed for repair or maintenance.

Disadvantage

Shaft ends and cables can be damaged.

Requires longer shafts.

The shaft may act as a preferential water flow. Solar radiation may heat up refilling tubes, which will influence water potential measurements.

Trench + Auger

This method is recommended if the sensor end and cables should not reach to the soil surface. The sensor and refilling tube are protected from frost.

After digging a trench, METER recommends using the tensiometer auger to dig a borehole the right size (Section 2.1.3). Installing into a trench wall may be easier than drilling the whole depth from soil surface. When installation is finished, either fill the trench or install an irrigation valve box to house the sensor cable and refilling tubes.

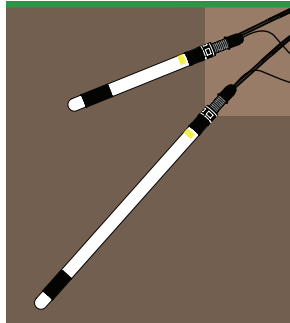
**Advantage**

Sensors are protected from damage at the surface.

Sensors are installed in frost-free zone.

Sensors installed at a greater depth than the tensiometer auger reaches.

Disadvantage

Large soil disturbance at measurement site.

Sensor replacement or maintenance requires digging up the trench.

Long refilling tubes are required.

2.1.1 INSTALLATION ANGLE

TEROS 32 must be installed at an angle (α) of 10° to 80° from horizontal (Figure 1). An angled installation position does not disturb typical water flow and avoids creating preferential water flow along the shaft. This position also allows for proper refilling in the ceramic cup. A vertical or horizontal position may retain air bubbles in the ceramic cup, and the water potential measurement may not be reliable. For installations in an upward position an installation angle from -10° to -80° from horizontal is recommended (Figure 1).

OPERATION

The exact installation angle will depend on the individual measuring task, site, and depth.

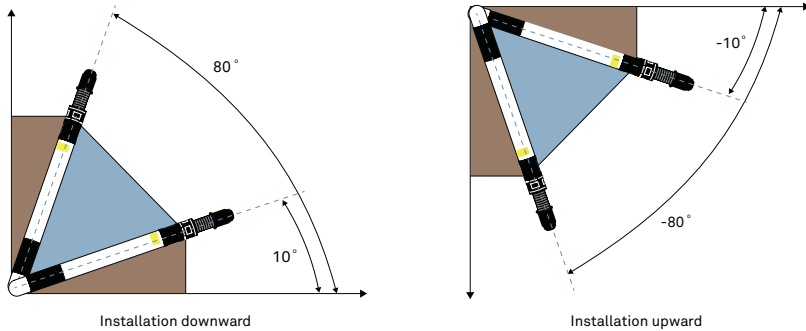

Figure 1 Recommended installation angles

Installation angle and pitch can be checked in real time using a ZL6 data logger and ZENTRA Utility. ZENTRA Utility can be downloaded on the METER [website](https://meter.ly/ZL6-support) for data logger support (<https://meter.ly/ZL6-support>). The ZSC Bluetooth® Sensor and ZENTRA Utility Mobile can also be used for installation (more information below and on the METER website).

ZENTRA UTILITY

When installing the sensor with ZL6 data logger and ZENTRA Utility, use the following steps:

1. Plug the TEROS 32 cable into the ZL6 sensor port.
2. Launch ZENTRA Utility software on a computer (Figure 2).

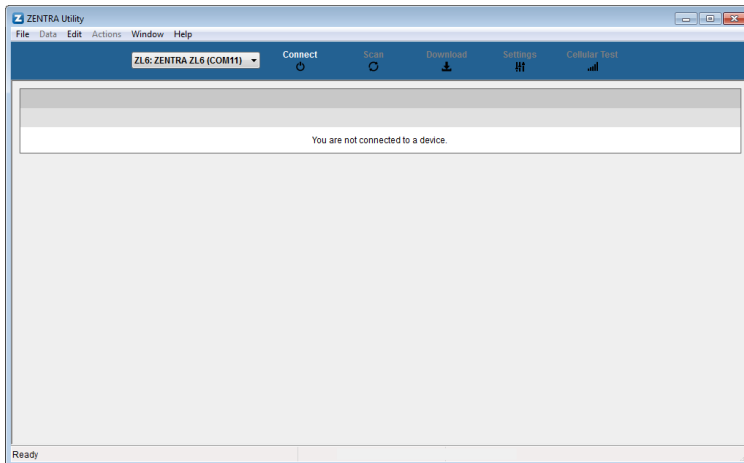

Figure 2 ZENTRA Utility initial screen

3. Click **Connect**.

Ensure the ZL6 connects correctly and the TEROS 32 is plugged in.

- Click **Settings** (Figure 3).

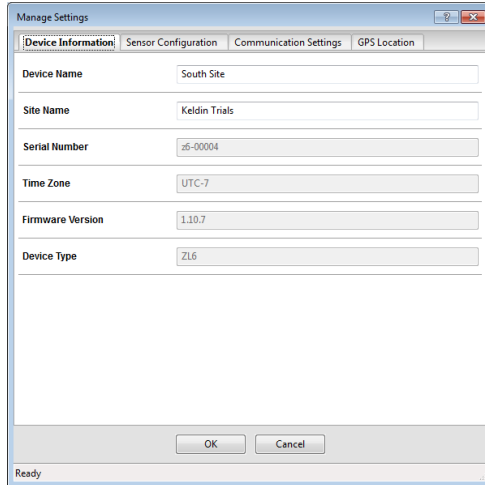

Figure 3 ZENTRA Utility Manage Settings dialog

- Select the **Sensor Configuration** tab (Figure 4).

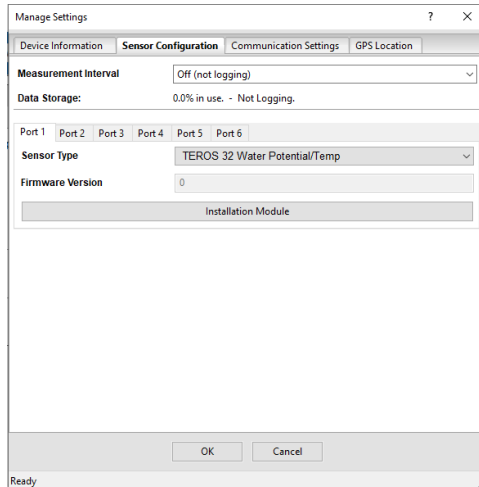

Figure 4 Sensor Configuration tab

- Select the port with the connected TEROS 32.
- Click **Installation Module**.

The TEROS Tensiometer Installation window will appear (Figure 5). Clicking the information icon will provide definitions of Pitch and Roll.

OPERATION

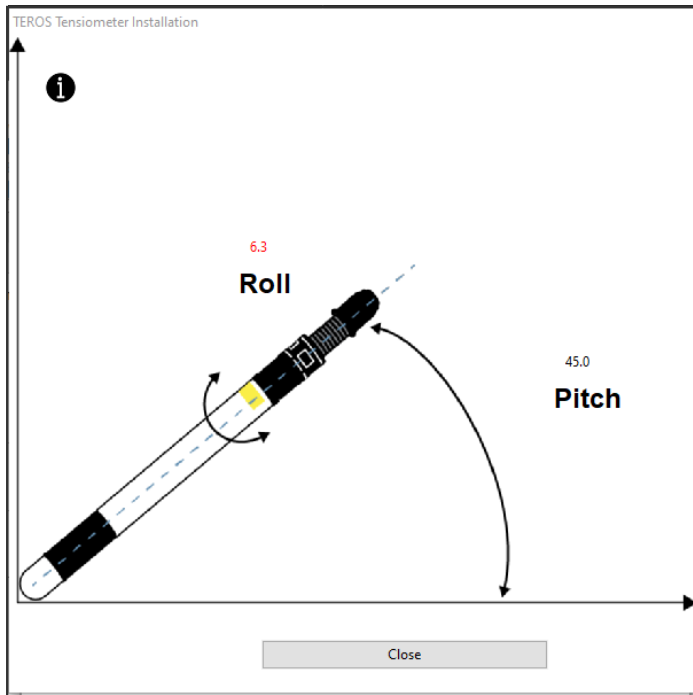

Figure 5 TEROS Tensiometer Installation dialog

8. Adjust the TEROS 32 until the numbers in the module match the desired values. Out-of-specification values will be displayed in red.
9. Click **C**lose.

More instructions for using ZENTRA Utility are in the [ZL6 User Manual](#).

ZSC BLUETOOTH

When installing the sensor with ZSC Bluetooth Sensor Interface and ZENTRA Utility Mobile use a smartphone or tablet. Install ZENTRA Utility Mobile using the following steps:

1. Open the application (app) store provided on the mobile device, smartphone, or tablet (Apple App Store® or Google Play™).
2. Use the search bar provided within the app store and search for ZENTRA Utility Mobile.
3. Select ZENTRA Utility from search results and download (app store may use "Install" as the option for downloading the ZENTRA Utility application).

NOTE: In order to have uploading capabilities, the ZENTRA Cloud feature is required. Please contact [Customer Support](#) for more information.

4. Launch or open ZENTRA Utility Mobile once it is downloaded.
5. Install the included AA batteries to the ZSC Bluetooth Interface and press the button to turn the device on.

The LED should begin blinking blue (refer to ZSC instructions for more details).

6. Plug in the TEROS 32 to the ZSC Bluetooth Interface with the stereo connector ([Figure 6](#)).

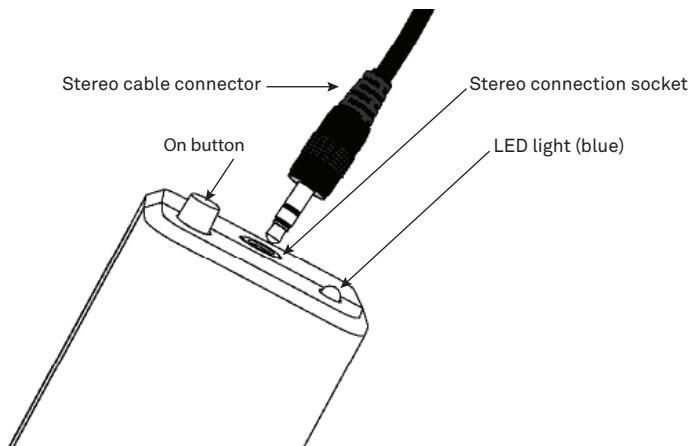

Figure 6 ZSC Bluetooth stereo cord connection

7. Look for the ZSC in the Devices Found window ([Figure 7](#)) and select ZSC to connect.

NOTE: NOTE: Serial numbers will vary. The example serial number below will not match what appears on each individual device.

OPERATION

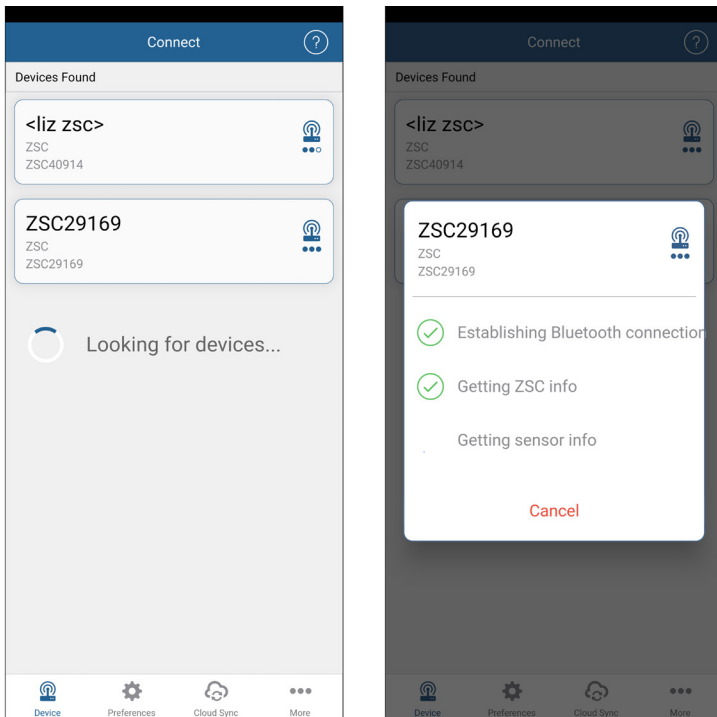

Figure 7 Views of ZSC Bluetooth interface connecting

Once connected, the ZENTRA Utility Mobile screen will show the sensor information and instantaneous sensor readings for installation (see [Figure 8](#)).

TEROS 32

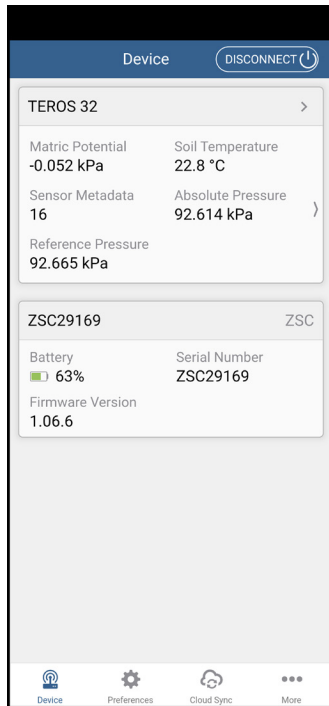

Figure 8 View of ZENTRA Utility Mobile Device overview

NOTE: See [ZSC Bluetooth User Manual \(https://meter.ly/ZSC\)](https://meter.ly/ZSC) for detailed directions on setting preferences such as measurement units.

8. Select More from the bottom right corner of the screen (below the three dots symbol).

OPERATION

- From the More menu (Figure 9) select Sensor Tools under the Tools category.
- On the Sensor Tools menu (Figure 9) select the Tensiometer Installation Tool option.

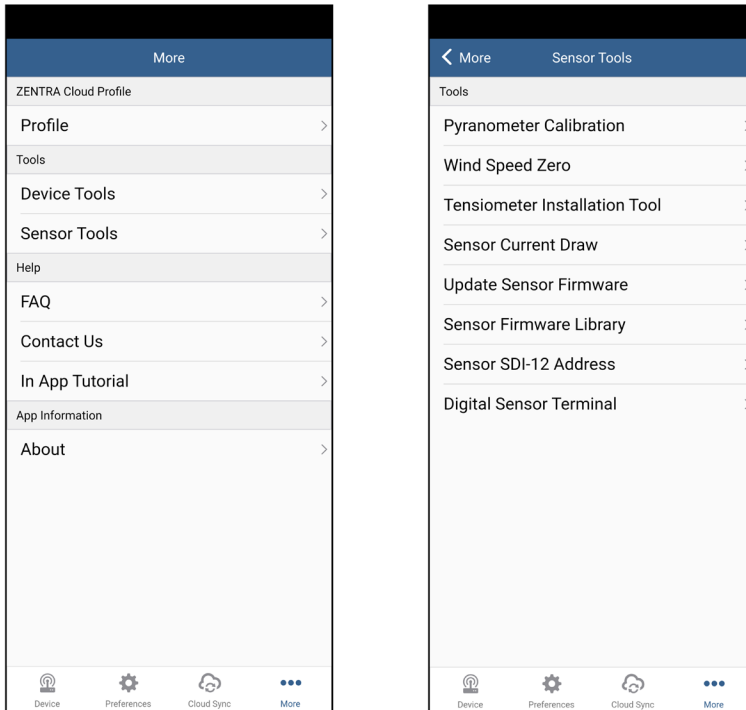

Figure 9 Views of More menu and Sensor Tools menu

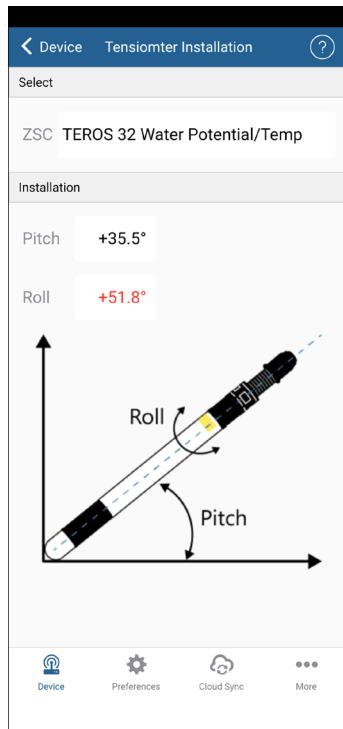

Figure 10 View of Tensiometer Installation tool

2.1.2 INSTALLATION DEPTH

Figure 11 shows the reference points for water potential measurement. Water potential is calibrated to the middle of the ceramic cup, so the measuring point is 1.5 cm from the ceramic tip.

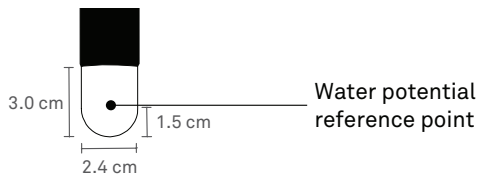

Figure 11 Position of reference points for water potential measurement

Use this reference point to determine the best installation depth for the desired application.

OPERATION

As TEROS 32 is always installed at an angle from horizontal (α), installation depth is not equal to drilling depth. To calculate the correct drilling depth, use or [Table 3](#).

$$\text{drilling depth} = \frac{\text{installation depth}}{\sin \alpha}$$

Equation 1

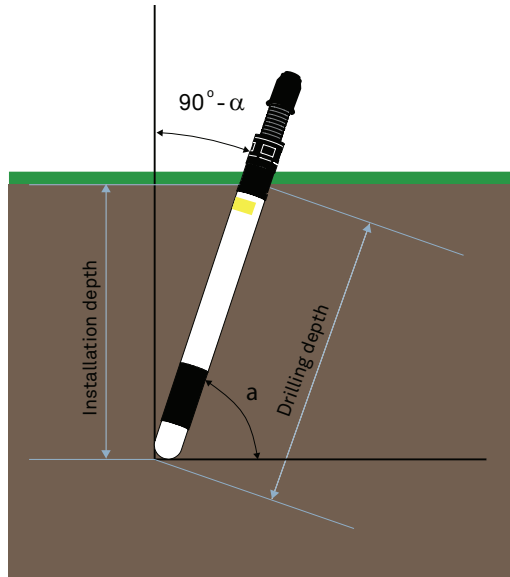

Figure 12 Drilling depth depending on installation angle

Table 3 Drilling depth in centimeters for installation depths and angles

	Installation Angle														
	80°	75°	70°	65°	60°	55°	50°	45°	40°	35°	30°	25°	20°	15°	10°
10	10	10	11	11	12	12	13	14	16	17	20	24	29	39	58
20	20	21	21	22	23	24	26	28	31	35	40	47	58	77	115
30	30	31	32	33	35	37	39	42	47	52	60	71	88	116	173
40	41	41	43	44	46	49	52	57	62	70	80	95	117	155	
50	51	52	53	55	58	61	65	71	78	87	100	118	146	193	
60	61	62	64	66	69	73	78	85	93	105	120	142	175		
70	71	72	74	77	81	85	91	99	109	122	140	166	205		
80	81	83	85	88	92	98	104	113	124	139	160	189			
90	91	93	96	99	104	110	117	127	140	157	180	213			
100	102	104	106	110	115	122	131	141	156	174	200				
110	112	114	117	121	127	134	144	156	171	192	220				
120	122	124	128	132	139	146	157	170	187	209					
130	132	135	138	143	150	159	170	184	202						
140	142	145	149	154	162	171	183	198	218						
150	152	155	160	166	173	183	196	212							
160	162	166	170	177	185	195	209								
170	173	176	181	188	196	208									
180	183	186	192	199	208	220									
190	193	197	202	210	219										
200	203	207	213	221											

To avoid damage to the sensor by frost, install the TEROS 32 in a frost-free soil horizon (in general, below 20 cm).

2.1.3 DRILLING WITH THE TENSIOMETER AUGER

METER recommends using only the specially designed tensiometer auger for installing the TEROS 32. This will result in good hydraulic contact with the soil. The tensiometer auger is specially shaped to prevent soil compaction near the ceramic area (Figure 13).

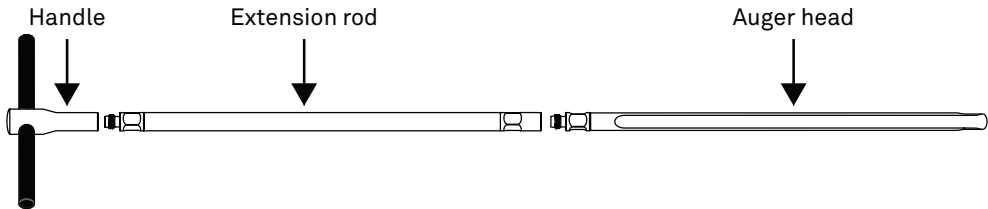

Figure 13 TEROS 32 auger components

The following steps detail how to use the tensiometer auger:

1. Assemble the auger using the handle, extension rods, and auger head.
2. Attach a magnetic level (set to measure the desired angle from vertical) on the length of the auger.
3. Place the auger tip on the ground and adjust to the calculated installation angle using the magnetic level as a guide.
4. Hit the handle gently a few times with a dead blow hammer until the auger head is 40 cm in the ground.
Check the level for the proper angle until the auger head is in far enough so that the angle does not change.
5. Rotate the auger one revolution clockwise to cut off the soil in the borehole.
6. Pull the auger out of the borehole after every 40-cm increment to avoid soil compaction.
7. Remove the soil inside the auger head.
8. Repeat [steps 3](#) through [7](#) until desired depth is reached, adding extension rods as needed.

2.2 FILLING THE CERAMIC CUP

The water potential measurement of TEROS 32 only works properly if the ceramic cup is completely filled with deionized and degassed water. Any air bubbles inside the ceramic cup will downgrade the quality of the water potential measurement.

TEROS 32 sensors are delivered unfilled. The sensors will need to be filled prior to first use.

NOTE: Refilling the sensor is not possible under freezing temperatures.

Use only deionised or distilled water to get the complete measurement range for water potential measurements. Using tap water may contaminate the internal tubes and ceramic cup.

1. Fill the refill syringe with about 40 mL of deionised water.
2. Remove air from the syringe.
3. Close the valve on the refill syringe and pull the syringe plunger to create a vacuum. Air bubbles will appear in the water.
4. Move the syringe up and down so the air bubbles collect near the syringe outlet.
5. Release the plunger to relieve the vacuum in the syringe.
6. Open the valve and push out the degassed air.
7. Repeat [step 3](#) through [step 6](#), 2 to 3 times ([Figure 14](#)).

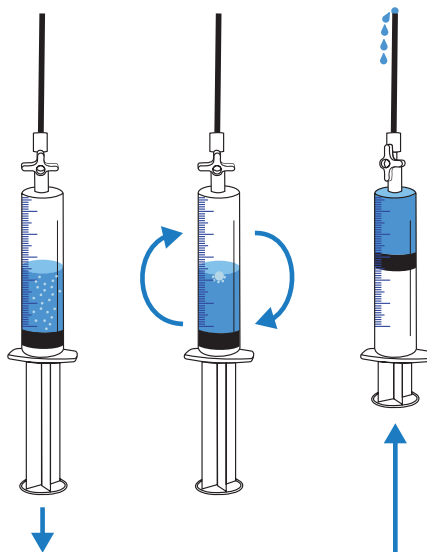

Figure 14 Degassing water in refill syringe

8. Disconnect the upper and lower refilling tubes.
9. For a downward installation, connect the syringe to the marked refilling tube from TEROS 32 ([Figure 15](#)).

For an upward installation, connect the syringe to the unmarked refilling tube.

NOTE: If the TEROS 32 is not installed, position the sensor at an angle of at least 10° from vertical with the yellow sticker pointing upwards to get the best refill result.

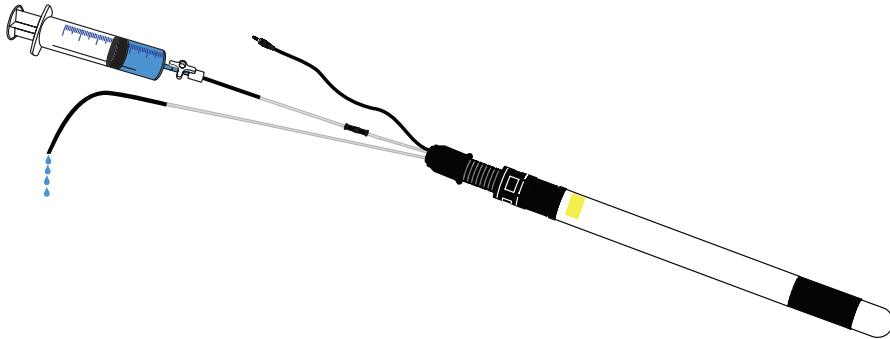

Figure 15 Teros 32 refilling

10. Press the syringe slowly, pushing the water into the Teros 32.
Continue to push the water into the sensor until only water comes out of the other refilling tube (Figure 15).
To be sure to get a perfect filling, press at least 20 mL water into the Teros 32.
11. Disconnect the syringe.
12. Reconnect the upper and lower refilling tubes.

The soil water potential may get higher than the Teros 32 measuring range (-85 kPa; Section 3.3.3). The water will evaporate from the ceramic cup and the sensor will stop measuring properly. The Teros 32 should be refilled when the soil is wet again (water potential is higher than -85 kPa). Refilling while soil water potential is lower than -85 kPa will not be successful. The water will evaporate and leave the ceramic cup again shortly after refilling.

2.3 CONNECTING

The Teros 32 works seamlessly with METER data loggers. The Teros 32 can also be used with other data loggers, such as those from Campbell Scientific, Inc. For extensive directions on how to integrate the sensors into third-party loggers, refer to the [Teros 32 Integrator Guide](#).

Teros 32 sensors require an excitation voltage in the range of 4.0 to 28.0 VDC and operate at a 4.0-VDC level for data communication. Teros 32 can be integrated using DDI Serial, SDI-12, Modbus RTU, or tensioLINK communications protocol. See the [Teros 32 Integrator Guide](#) for details on interfacing with data acquisition systems.

Teros 32 sensors come with a 3.5-mm stereo plug connector (Figure 16) to facilitate easy connection with METER loggers. Teros 32 sensors may be ordered with stripped and tinned wires to facilitate connecting to some third-party loggers (Section 2.3.2).

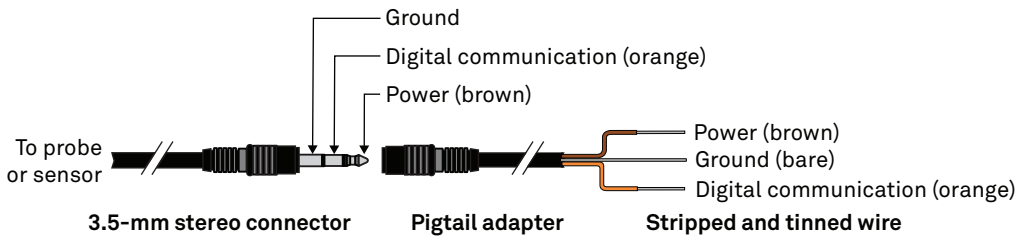

Figure 16 Three-wire stereo connector and pigtail adapter

The TEROS 32 comes standard with a 5-m cable. It may be purchased with custom cable lengths for an additional fee (on a per-meter basis). In some instances, the cable can be extended beyond 75 m by the user, but this is discouraged for a variety of reasons. Please contact [Customer Support](#) for more details before extending or splicing cables.

2.3.1 CONNECT TO METER DATA LOGGER

The TEROS 32 works most efficiently with METER ZENTRA series data loggers. Check the [METER download webpage](#) for the most recent data logger firmware. Logger configuration may be done using either ZENTRA Utility (desktop and mobile application) or ZENTRA Cloud (web-based application for cell-enabled ZENTRA data loggers).

1. Plug the stereo plug connector into one of the sensor ports on the logger.
2. Use the appropriate software application to configure the chosen logger port for the TEROS 32.

METER data loggers will automatically recognize TEROS 32 sensors.

3. Set the measurement interval.

METER data loggers measure the TEROS 32 every minute and return the average of the 1-min data across the chosen measurement interval.

TEROS 32 data can be downloaded from METER data loggers using either ZENTRA Utility or ZENTRA Cloud. Refer to the logger user manual for more information about these programs.

2.3.2 CONNECT TO NON-METER DATA LOGGER

The TEROS 32 can be used with non-METER (third-party) data loggers or data acquisition systems. Refer to the third-party logger manual for details on logger communications, power, and ground ports. The [TEROS 32 Integrator Guide](#) also provides detailed instructions on connecting sensors to non-METER loggers.

TEROS 32 sensors can be ordered with stripped and tinned (pigtail) wires for use with screw terminals. METER recommends using a 4-pin M12 plug connector and a connection cable with open wires for use with a non-METER data logger using either SDI-12, tensioLINK serial, or Modbus RTU communications protocol.

OPERATION

Connect the TEROS 32 wires to the data logger as illustrated in [Figure 17](#) through [Figure 20](#) with the supply wire (brown) connected to the excitation, the digital output wire (orange) to a digital input, and the bare ground wire to ground.

NOTE: The acceptable range of excitation voltages is from 4.0 to 28.0 VDC. To read TEROS 32 with Campbell Scientific, data loggers, power the sensors from a switched 12-V port or a 12-V port if using a multiplexer.

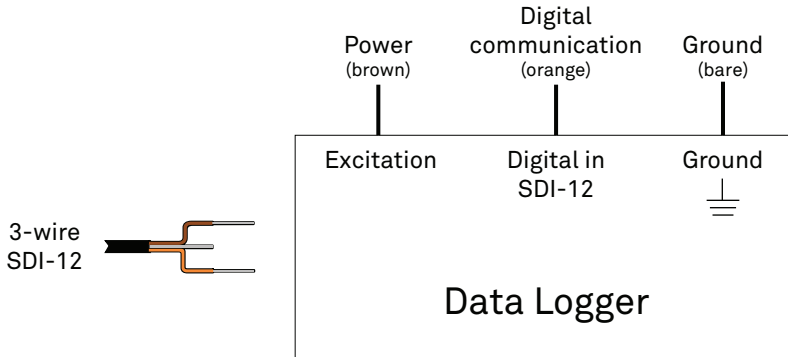

Figure 17 Three-wire pigtail SDI-12 wiring diagram

For RS-485, the power supply wire (brown) will be connected to the excitation, the digital communication + wire (white) to a digital input (high), the digital communication - wire (black) to a digital input (low) and the blue ground wire to ground. For SDI-12, both the digital communication - and ground wires will both be connected to ground.

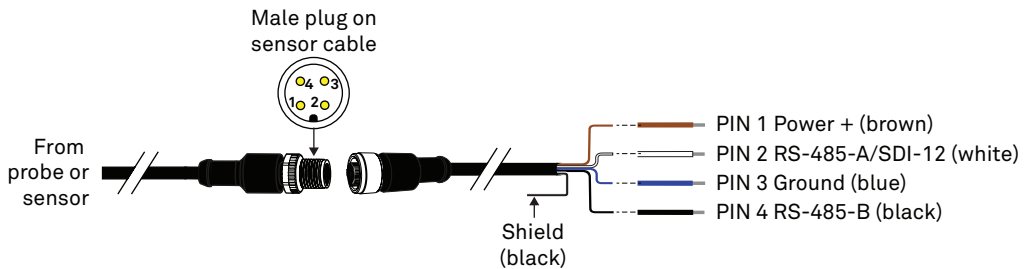

Figure 18 Four-wire M12 connector and pigtail adapter

TEROS 32

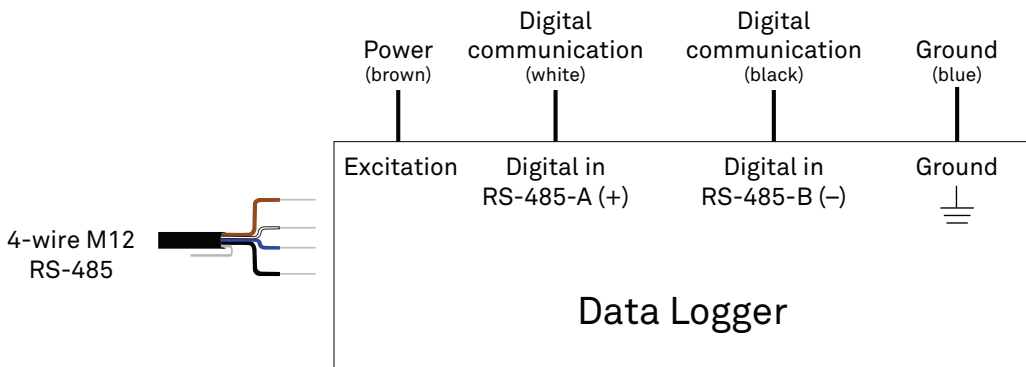

Figure 19 Four-wire M12 connector RS-485 wiring diagram

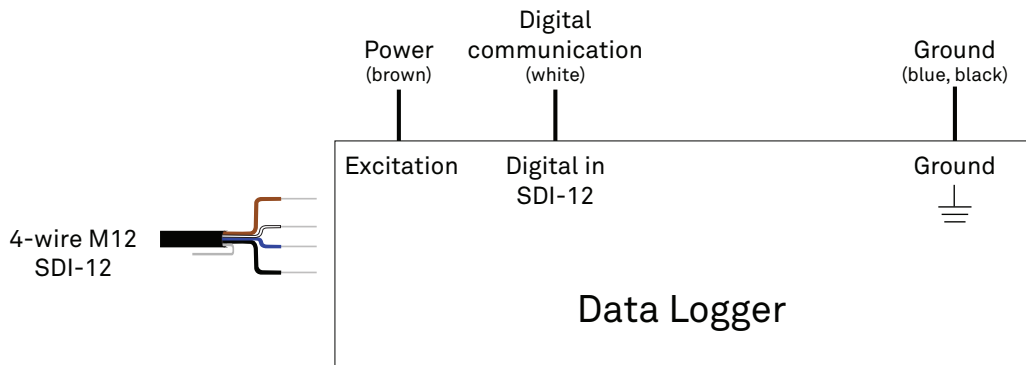

Figure 20 Four-wire M12 connector SDI-12 wiring diagram

If the TEROS 32 cable has a standard stereo plug connector and needs to be connected to a non-METER data logger, use one of the following two options.

Option 1

1. Clip off the stereo plug connector on the sensor cable.
2. Strip and tin the wires.
3. Wire it directly into the data logger.

This option has the advantage of creating a direct connection and minimizes the chance of the sensor becoming unplugged. However, it then cannot be easily used in the future with a METER readout unit or data logger.

Option 2

Obtain an adapter cable from METER.

The adapter cable has a connector for the stereo plug connector on one end and three wires (or pigtail adapter) for connection to a data logger on the other end. The stripped and tinned adapter cable wires have the same termination as in [Figure 18](#): the brown wire is excitation, the orange is output, and the bare wire is ground.

NOTE: Secure the stereo plug connector to the pigtail adapter connections using adhesive-lined heat shrink to ensure the sensor does not become disconnected during use.

2.4 COMMUNICATION

The TEROS 32 communicates using DDI serial and SDI-12 communication protocol. To obtain detailed instructions, refer to the [TEROS 32 Integrator Guide](#).

The SDI-12 protocol requires that all sensors have a unique address. TEROS 32 sensor factory default is an SDI-12 address of 0. To add more than one SDI-12 sensor to a bus, the sensor address can be changed using a ZSC Bluetooth sensor interface and the ZENTRA Utility Mobile app as described below:

NOTE: The sensor SDI-12 address must be returned to 0 to work with ZENTRA loggers.

1. Using a mobile device, open the ZENTRA Utility Mobile app.
2. Connect the sensor to the ZSC.
3. Select More from the bottom right corner of the screen (below the three dots symbol).
4. From the More menu ([Figure 9](#)) select Sensor Tools.
5. On the Sensor Tools menu ([Figure 9](#)) select the Sensor SDI-12 Address option.
6. Scroll through the options and select the desired SDI-12 address.

NOTE: Address options include 0-9, A-Z, and a-z.

Detailed information can also be found in the application note [Setting SDI-12 addresses on METER digital sensors using Campbell Scientific data loggers and LoggerNet](#).

When using the sensor as part of an SDI-12 bus, excite the sensors continuously to avoid issues with initial sensor startup interfering with the SDI-12 communications.

2.5 REMOVAL

To remove the sensor from the soil, pull gently on the sensor shaft until the sensor is out of the soil.

 WARNING

Do not pull by the cable! Doing so may break internal connections and make the sensor unusable.

3. SYSTEM

This section describes the TEROS 32 sensor.

3.1 SPECIFICATIONS

MEASUREMENT SPECIFICATIONS

Water Potential

Range	-85 to +50 kPa
-------	----------------

Resolution	0.0012 kPa
------------	------------

Accuracy	± 0.15 kPa
----------	----------------

Temperature

Range	-30 to +60 °C
-------	---------------

Resolution	± 0.01 °C
------------	---------------

Accuracy	± 0.1 °C between -20 and +40 °C (± 1 °C outside of this range)
----------	--

COMMUNICATION SPECIFICATIONS

Output

DDI serial and SDI-12 communications protocol

3- or 4-wire cable version ([Figure 17](#))

RS-485 4-wire cable version ([Figure 19](#))

Modbus RTU and tensioLINK serial communication protocol

3- or 4-wire cable version ([Figure 17](#))

RS-485 4-wire version ([Figure 19](#))

Data Logger Compatibility

METER ZL6 and EM60 data loggers or any data acquisition system capable of 4.0- to 28.0-VDC power and serial interface with SDI-12; and/or RS-485 interface, Modbus RTU, or tensioLINK communication.

PHYSICAL SPECIFICATIONS

Dimensions

Length	40.0 cm (15.75 in)
	80.0 cm (31.50 in)
	120.0 cm (47.24 in)

Diameter	2.5 cm (0.98 in)
----------	------------------

SYSTEM

Operating Temperature

Minimum	-30 °C (0 °C for water-filled tensiometer)
Typical	NA
Maximum	50 °C

Materials

Ceramic	Al ₂ O ₃ , bubble point 1,500 kPa
Shaft	PMMA
Corpus	POM GF
Refilling tubes	Stainless steel

Installation Angle

10° to 80° from horizontal (downward)
-10° to -80° from horizontal (upward)

Cable Length

5 m (standard)
75 m (maximum custom cable length)

NOTE: Contact [Customer Support](#) if a nonstandard cable length is needed.

Cable Diameter

Stereo Plug 4.2 ±0.2 mm (0.16 ±0.01 in) with minimum jacket of 0.8mm (0.031 in)

M12 Plug 5.5 ±0.2 mm (0.22 ±0.01 in) with minimum jacket of 1.0 mm (0.039 in)

Connector Size

3.50 mm (diameter)

14.4 mm (diameter M12)

Connector Types

Stereo plug connector or stripped and tinned wires

4-pin M12 connector or stripped and tinned wires

Conductor Gage

Stereo Plug	22-AWG / 24-AWG ground wire
M12 Plug	22-AWG

ELECTRICAL AND TIMING CHARACTERISTICS**Supply Voltage (power to ground)**

Minimum	4.0 V
Typical	12.0 V
Maximum	28.0 V

Digital Input Voltage (logic high)

Minimum	1.6 V
Typical	3.3 V
Maximum	5.0 V

Digital Input Voltage (logic low)

Minimum	-0.3 V
Typical	0.0 V
Maximum	0.9 V

Digital Output Voltage (logic high)

Minimum	NA
Typical	3.6 V
Maximum	NA

Power Line Slew Rate

Minimum	1.0 V/ms
Typical	NA
Maximum	NA

Current Drain (during measurement)

Minimum	18 mA
Typical	25 mA
Maximum	30 mA

Current Drain (while asleep)

Minimum	0.03 mA
Typical	0.05 mA
Maximum	0.90 mA

Power Up Time (DDI serial)

Minimum	125 ms
Typical	130 ms
Maximum	150 ms

Power Up Time (SDI-12)

Minimum	125 ms
Typical	160 ms
Maximum	175 ms

Measurement Duration

Minimum	60 ms
Typical	65 ms
Maximum	70 ms

COMPLIANCE

EM ISO/IEC 17050:2010 (CE Mark)

2014/30/EU and 2011/65/EU

EN61326-1:2013 and EN55022/CISPR 22

3.2 COMPONENTS

The TEROS 32 sensor measures soil water potential and temperature (Figure 21). Water potential is measured using a water-filled porous ceramic cup at the end of the sensor unit conducted to an absolute pressure transducer. Soil temperature is measured inside the pressure transducer.

TEROS 32 has a low power requirement, which makes it ideal for permanent burial in the soil. The sensor can be read continuously with a data logger or periodically with a handheld reader.

TEROS 32 has multiple accessories (Figure 21). The cable gland, bend protection, and dust cap protect the sensor cable and refilling tubes. The bend protection and dust cap can be removed if they are not needed for the application. The flow diversion disk prevents rain water from running down the shaft inside the borehole. If the TEROS 32 sensor is completely buried, the flow diversion disk is not needed.

TEROS 32

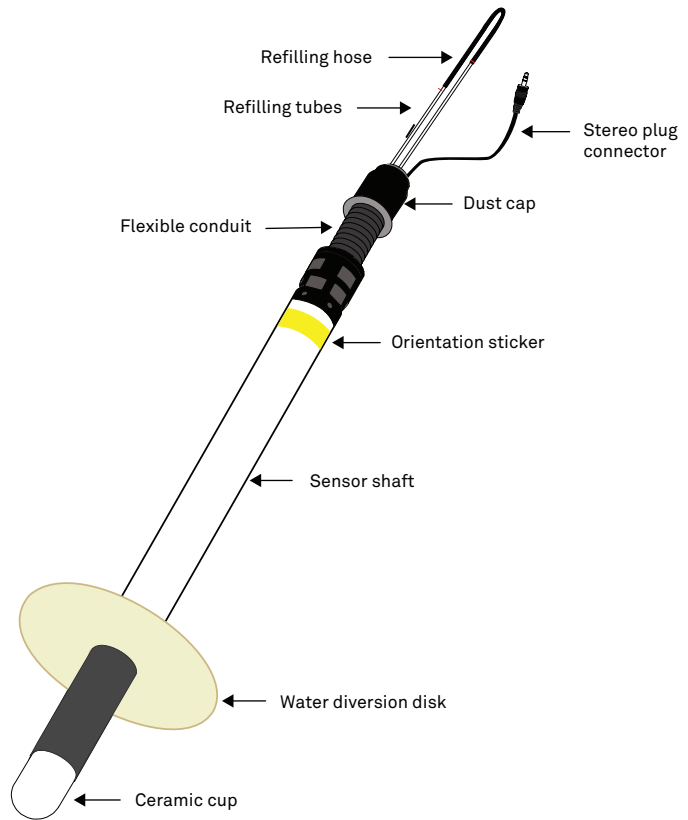

Figure 21 TEROS 32 sensor

3.3 THEORY

The following sections explain the theory of soil water potential measurements.

3.3.1 WATER POTENTIAL MEASUREMENTS

All soil water potential measurement techniques measure the potential energy of water in equilibrium with water in the soil. The Second Law of Thermodynamics states that connected systems with differing energy levels move toward an equilibrium energy level. When an object, such as the TEROS 32 ceramic cup, comes into hydraulic contact with the soil, the water potential of the object comes into equilibrium with the soil water potential.

The water in the ceramic cup transmits the total potential from the soil water through the porous ceramic to the pressure transducer. The ceramic cup acts as a semipermeable diaphragm with a very high water conductivity. It is very important to get a good capillary contact to the surrounding soil.

Equation 2 gives the component variables for determining total soil water potential (Ψ_t).

$$\Psi_t = \Psi_p + \Psi_g + \Psi_o + \Psi_m$$

Equation 2

where:

- Ψ_p is atmospheric pressure
- Ψ_g is gravitational potential
- Ψ_o is osmotic potential
- Ψ_m is matric potential

For TEROS 32 applications, Ψ_g is generally insignificant. Ψ_p should be measured by a reference sensor (Section 3.3.2). Ψ_o arises from dissolved salts in the soil and becomes important only if a semipermeable barrier is present that prevents ionic movement. The TEROS 32 ceramic cup has a pore size of $r = 0.3 \mu\text{m}$ and cannot block ions, so the osmotic potential is negligible. Ψ_m arises from the attraction of water to the soil particles and is the most important component of water potential in most soils. TEROS 32 responds to the matric potential of the soil (Ψ_m).

3.3.2 BAROMETRIC COMPENSATION

TEROS 32 measures the sum of matric potential and atmospheric pressure potential ($\Psi_p + \Psi_m$). To extract the matric potential, the barometric pressure should also be registered with a reference sensor. METER ZL6 and EM60 data loggers include a barometric pressure sensor and convert the signal into soil water potential. One atmospheric pressure sensor at every measuring site is enough to convert all TEROS 32 measurements at this site.

If using a non-METER data logger, a barometric sensor is needed at the measuring site. A barometric sensor is available from METER by contacting [Customer Support](#).

3.3.3 MEASUREMENT RANGE

The measuring range of tensiometers is limited by the boiling point of water. At a temperature of 20 °C, the boiling point is at 2.3 kPa over vacuum. So with 20 °C and an atmospheric pressure of 95 kPa the tensiometer cannot measure a tension below -92.7 kPa, even if the soil gets drier than that. The readings remain at a constant value as shown in [Figure 22](#) between days 10 and 16).

If the soil becomes drier and reaches -1,500 kPa, the ceramic air-entry point is reached. The water in the ceramic cup will dry out quickly, and the reading of the air-filled cup will drop to 0 kPa, even if soil gets drier ([Figure 22](#), day 16 to 19).

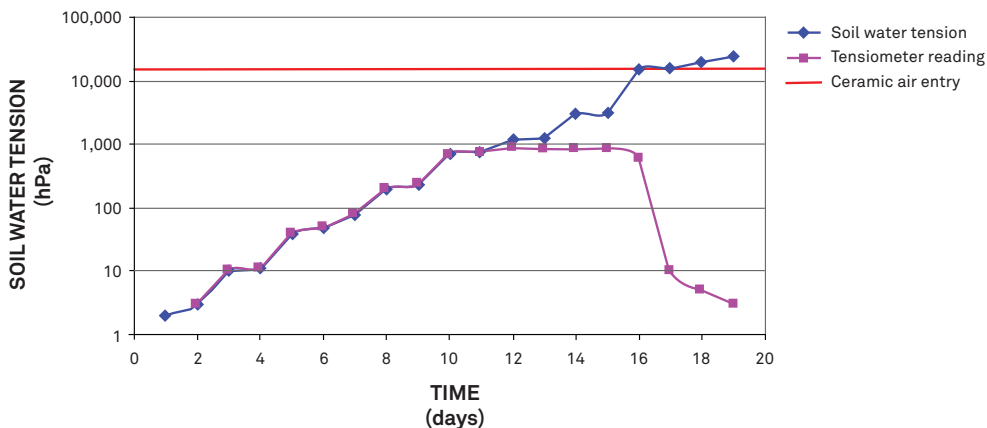

Figure 22 Tensiometer readings with tensions to -1,500 kPa

If there will be rain before the soil water potential reaches -1,500 kPa, the tensiometer cup will absorb the soil water. The soil water includes dissolved gas. If soil water potential increases, the dissolved gas will expand and will limit the measuring range. This will result in a slow response—the signal curve will get flatter, and the readings will slowly approach the actual soil water potential. Depending on the size of the developed bubble, readings will get further from the actual water potential ([Figure 23](#), after day 20).

SYSTEM

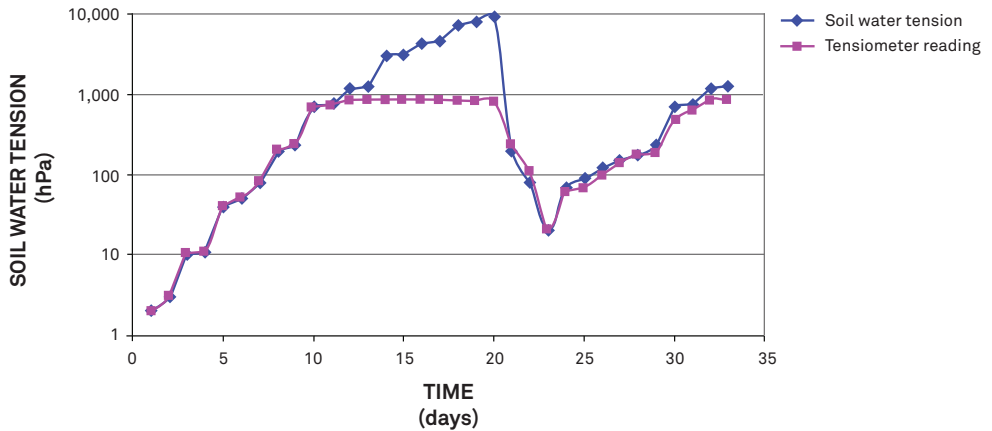

Figure 23 Tensiometer readings with tensions to -1,000 kPa

In saturated soils or measuring sites with perched water the TEROS 32 will measure pressure potentials.

3.3.4 TEMPERATURE

The TEROS 32 uses the integrated temperature sensor of the pressure transducer to take temperature readings. The TEROS 32 sensor output temperature is in degrees Celsius unless otherwise stated in the data logger program, such as in preferences in the ZENTRA software.

4. SERVICE

This section contains calibration and recalibration information, calibration frequencies, cleaning and maintenance guidelines, troubleshooting guidelines, customer support contact information, and terms and conditions.

4.1 CALIBRATION

METER software tools automatically apply factory calibrations to the sensor output data.

4.2 MAINTENANCE

The TEROs 32 may be returned to METER for maintenance in the following areas: system inspection, parts replacement, and instrument cleaning. Replacement parts can also be ordered from METER. Contact [Customer Support](#) for more information.

The nominal lifespan for outdoor usage is 10 years, but the lifespan can be substantially extended by proper and careful usage and by protecting the sensor against UV radiation and frost.

Depending on the installation site, the TEROs 32 ceramic cup may dry out. To assure a rapid and reliable measurement of the soil water potential, the ceramic cup must be filled with deionised water after dry periods or periods with a large number of wet and drying out cycles ([Section 2.2](#)).

NOTE: Refilling is only reasonable if the soil is wetter than -85 kPa after a dry period.

If the water potential values seem incorrect, use the following steps to check the zero point of the TEROs 32 pressure transducer.

1. Place the TEROs 32 (with a properly filled ceramic cup) vertically in a beaker.
2. Fill the beaker with deionized water to a water level of 5 cm.
3. Connect the TEROs 32 to a handheld or data logger and wait until the signal is stable (may take a few minutes).

The readings should be about $+0.3$ kPa (compensated value) or the actual barometric pressure $+0.3$ kPa (uncompensated value).

4.3 CLEANING

For storage, troubleshooting, reinstallation, or installing at new sites, cleaning may be needed.

The TEROs 32 shaft is made of acrylic ([Figure 21](#)). Acrylic is susceptible to alcohol and other solvents. Clean the TEROs 32 as needed with only water, ideally with deionized or degassed water to prevent damage to the ceramic cup on the end of the TEROs 32.

WARNING

Use of tenside or any other cleaner will make the ceramic cup unusable.

Exposure to oils or other hydrophobic substances compromises the ability of the ceramic cup to get capillary contact to the soil. This inability to get capillary contact leads to slow equilibration times and loss of accuracy. Minimize exposure of the ceramic material to skin oils, grease, synthetic oils, or other hydrophobic compounds. Using gloves to handle and clean the ceramic cup is recommended.

4.3.1 CLEANING THE EXTERIOR

To clean the TEROS 32, it is important to not use any sort of tensides, alcohol, or soaps.

1. Rinse the TEROS 32 avoiding the cables using clean water, deionized or degassed if possible.
2. Use a damp, soft cloth to remove any debris that does not easily rinse off (again using clean water and no soaps).
3. Dry with a clean, nonabrasive material.

4.3.2 CLEANING THE CERAMIC CUP

To clean the inside of the ceramic cup, first clean the exterior ([Section 4.3.1](#)).

NOTE: Use of gloves to handle and clean the ceramic cup will minimize exposing the ceramic cup to oils that can damage the TEROS 32.

1. Remove the ceramic cup by unscrewing it from the shaft, turning counterclockwise. Do not use any tools to unscrew the ceramic cup as it will damage the ceramic.
2. Rinse the ceramic cup using deionized or degassed water.
3. Use a small soft brush (e.g. a toothbrush) to remove any debris that does not come off easily with rinsing.

NOTE: Do not use any sharp objects to clean difficult to remove debris from the ceramic cup. Sharp objects may damage the transducer or the ceramic cup.

4.4 TROUBLESHOOTING

Table 4 lists common problems and their solutions. Most issues with the TEROS 32 sensor will manifest themselves in the form of incorrect or erroneous readings. If the problem is not listed or these solutions do not solve the issue, contact [Customer Support](#).

Table 4 Troubleshooting the TEROS 32

Problem	Possible Solutions
Data logger is not recognizing sensor	<p>If using a METER logger, update logger firmware.</p> <p>Check the logger configuration for a non-METER data logger using its user manual.</p>
Data logger is not receiving readings from the sensor	<p>Check that the connections to the data logger are both correct and secure.</p> <p>Ensure that data logger batteries are not dead or weakened.</p> <p>Check configuration of data logger through software to ensure TEROS 32 is selected.</p> <p>Ensure the software and firmware is up to date.</p>
Sensor is not responding	<p>Check power to the sensor.</p> <p>Check sensor cable and connector integrity.</p> <p>Check data logger wiring is correct (Section 2.3).</p>
Matric potential signal steps up and down	<p>Check capillary contact to the soil.</p> <p>Check connection at data logger plug.</p> <p>Check cable insulation.</p>
Matric potential signal does not increase even when soil is getting dry	<p>Refill TEROS 32 ceramic with deionised water (Section 2.2).</p> <p>Check the ceramic cup may be damaged.</p>
Cable or connector failure	<p>If a stereo plug connector is damaged or needs to be replaced, contact Customer Support for a replacement connector and splice kit.</p> <p>If a cable is damaged, follow the guidelines in Section 2.3 for wire splicing and sealing techniques.</p>

4.5 CUSTOMER SUPPORT

NORTH AMERICA

Customer service representatives are available for questions, problems, or feedback Monday through Friday, 7:00 am to 5:00 pm Pacific time.

Email: support.environment@metergroup.com
sales.environment@metergroup.com

Phone: +1.509.332.5600

Fax: +1.509.332.5158

Website: metergroup.com

EUROPE

Customer service representatives are available for questions, problems, or feedback Monday through Friday, 8:00 to 17:00 Central European time.

Email: support.europe@metergroup.com
sales.europe@metergroup.com

Phone: +49 89 12 66 52 0

Fax: +49 89 12 66 52 20

Website: metergroup.de

If contacting METER by email, please include the following information:

Name	Email address
Address	Instrument serial number
Phone	Description of the problem

NOTE: For products purchased through a distributor, please contact the distributor directly for assistance.

4.6 TERMS AND CONDITIONS

By using METER instruments and documentation, you agree to abide by the METER Group, Inc. Terms and Conditions. Please refer to metergroup.com/terms-conditions for details.

INDEX

A

accuracy **24**
 auger **2, 16**

B

barometric reference sensor **3, 29**

C

calibration **32**
 cleaning **32**
 communication **22**
 compliance **27**
 components
 accessories **27**
 ceramic cup **2, 27**
 flow diversion disk **3**
 refill tube **17–18, 27**
 connecting
 METER logger **18–19**
 non-METER logger **19–20, 29**
 connector types **18, 25**
 customer support **34**

E

email address **34, 35**

F

fax number **34, 35**

I

installation
 angle **3, 5–13, 15, 25**
 depth **3**
 filling **4, 16–18**
 methods **5**
 tools needed **2**
 ZENTRA Utility module **6–13**
 ZSC Bluetooth Sensor **6, 9**

M

maintenance **32**
 measurements **24–26**

P

phone number **34, 35**

R

range **24**
 refill syringe **2, 17–18**
 removal **23**

S

SDI-12 **22**
 specifications **24–27**
 communication **24**
 data logger compatibility **24**
 electrical and timing characteristics
 26–27
 measurement **24**
 physical **24**

T

temperature **24, 27**
 terms and conditions **35**
 theory **28–32**

W

water potential **18, 24, 27, 28–29**

Z

ZENTRA
 ZENTRA Cloud **19**
 ZENTRA Utility **6–13, 19**
 ZENTRA Utility Mobile **6, 9, 10, 11, 22**
 ZSC **6, 9, 10, 11, 22**

METER Group, Inc.

2365 NE Hopkins Court Pullman, WA 99163
T: +1.509.332.2756 F: +1.509.332.5158
E: info@metergroup.com W: metergroup.com

METER Group GmbH

Mettlacher Straße 8, 81379 München
T: +49 89 1266520 F: +49 89 12665220
E: info.europe@metergroup.com W:
metergroup.de

